



**HONG KONG PIEZO CO. LTD.**  
**香港功能陶瓷有限公司**

## Piezoceramic Buzzers

Model No: HKP-33P-10

Unit: mm

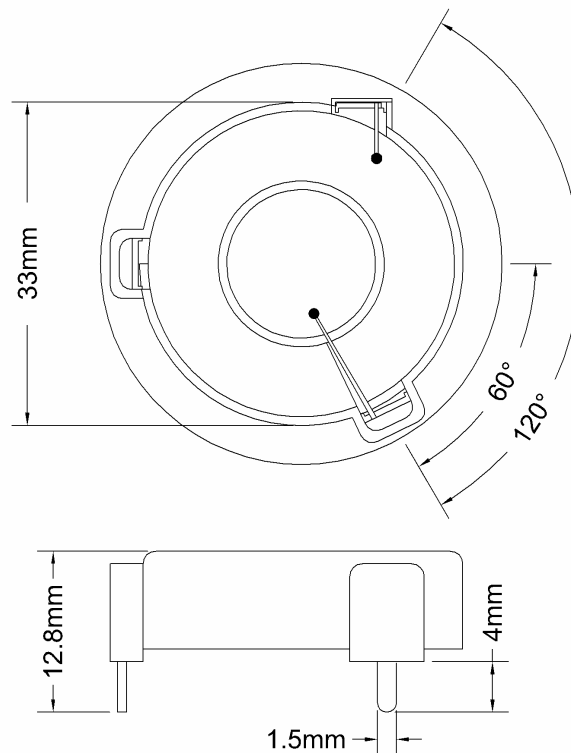

No.	Item	Specification
1	Dimension	Ø33.0 x H8.8mm
2	Sound Pressure Level	70dB min at 10cm 3Vrms Sine wave
3	Resonant Frequency	1.0±0.3KHz
4	Capacitance	55nf ± 30%
5	Operating Voltage	30Vp-p max
6	Operating Temperature	-20°C ~+70°C