



HONG KONG PIEZO CO. LTD.
香港功能陶瓷有限公司

Piezoceramic Buzzers

Model No: HKP-14P-40A

Unit: mm

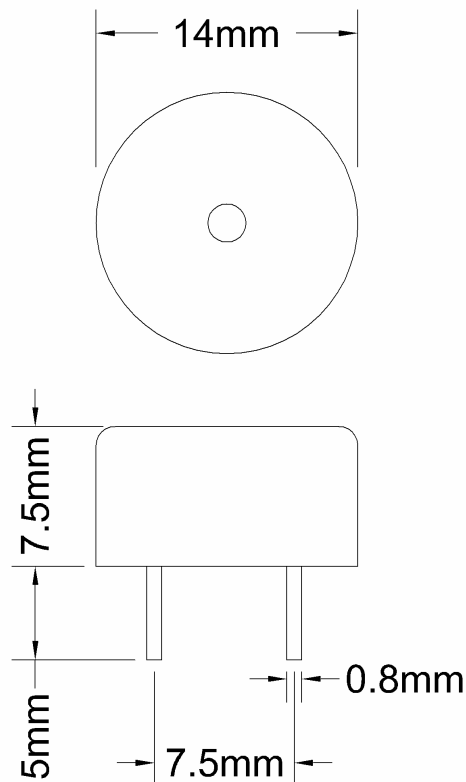

No.	Item	Specification
1	Dimension	Ø14.0 x H7.5mm
2	Sound Pressure Level	80dB min at 10cm 3Vrms Sine wave
3	Resonant Frequency	4.0±0.5KHz
4	Capacitance	15nf ± 30%
5	Operating Voltage	30Vp-p max
6	Operating Temperature	-20°C ~+70°C